

Catalog
Woodworking



Technology that attracts™

Magswitch Technology has evolved from a single technology company with a focus on welding and wood products in North America to a Global company with more than 65 patents world-wide and a major supplier to Automotive Infrastructure and Industrial resource industries on three continents. As we continue to expand with new technologies in more complex Lifting systems, Robotics, Cobotics tools, operating software and developing onshore manufacturing, we do so with a clear corporate objective. We want to be with our customers "At every step of the way". The small business that buys a 300amp ground clamp today, will want safer lifting and positioning tools, will have an interest in simple automated systems, some eventually to partial or fully automated welding and fabrication. Magswitch is at each step with the best gripping technology and partnerships with major OEMs and integrators to deliver a seamless solution, be it sheet leveling, smart cutting table unloading or fully automated fabrication and parts handling. We will not lose sight of our core business commitments, to **increase safety, productivity and efficiency** to ensure our **products meet or exceed the expectations** of our valued customers. Our mission is to ensure we continue to develop new solutions ahead of industry needs.



Benefits

- 100% Fail-safe technology
- True On/Off
- Magnet stays clean
- Magnets do not require an electrical power source
- Stronger & scalable force allows a better control
- Precise positioning



Safety

We consider safety in everything we do. If you work around steel, safety is the first consideration. Fewer hands on the job touching steel means a safer workplace. Safety is crucial to our products – easy actuation, lighter lifting, stability control and lift-to-shear capabilities all tie back to an emphasis on safety.



Sustainability

Magswitch products are a green technology utilizing the enduring power of rare earth magnets with low energy consumption.



Our Success

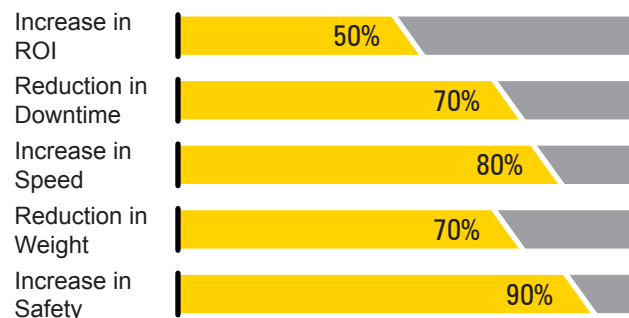

Magswitch DNA

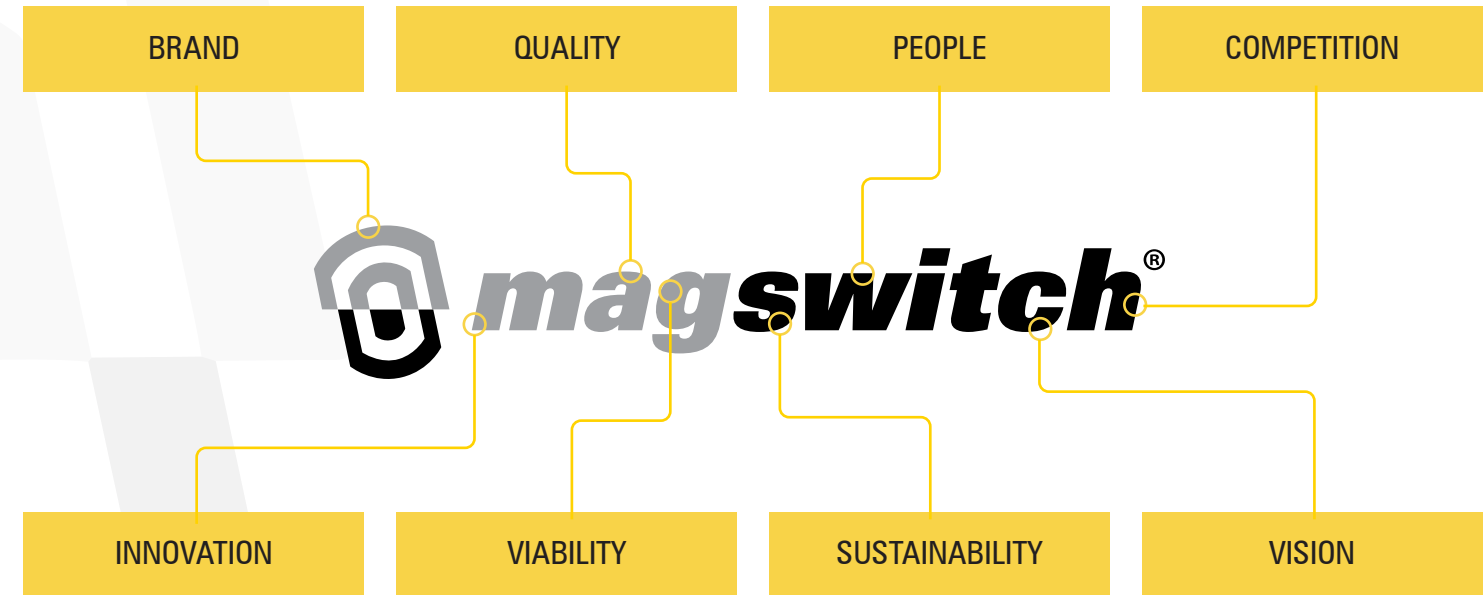

Magswitch Technology, headquartered in Colorado, USA, is a leader in switchable magnetic technology. From initial development, design and engineering to manufacturing, final delivery and distribution, Magswitch has paved the way for innovation in multiple industries across the globe.

Magswitch has evolved from manufacturing magnetic tools to engineering innovative technology to increase safety, productivity and speed in industries such as welding, fabrication, automation, manufacturing, heavy industry, woodworking and more.

With numerous patents and patents pending in all industrialized markets across the globe, Magswitch has evolved into a global integrated business. We are committed to a business model that identifies key industry partners, allowing the corporation to leverage its technology and products through recognized global distributors.



Accessory Products

Take a look at our accessory products for various Magswitch tools.

Please contact cs@magswitch.com for further information.



High-Heat-Tools

Magswitch tools are also available as a High-Heat-Variant.

Simply contact cs@magswitch.com for further information.



Visit our webshop! www.mag-tools.eu



Commercial Products

Applications: Woodworking, Fixturing, Drilling

The Magswitch Drill Press Vise Mount makes it fast and easy to position and lock a drill press vise in place on a drill press table.

- Four drop-in bolts that fit three T-slots positioned to accommodate a wide range of drill press vise mounting hole patterns
- Can be placed anywhere on a cast iron drill press table and finely positioned until it is in place
- Four powerful switchable magnets turn on with the flip of a switch to lock the vise in place for the drilling operation



81001385



81001385



81001385



Drill Press Vise Mount

Part No.	81001385
Max. Breakaway	325,63 kg
Height	84 mm
Width	195 mm
Length	201 mm
Weight	4,25 kg

Applications: Woodworking, Fixturing

The Magswitch Power Feeder Mount makes it fast and easy to position and lock a power feeder to cast iron tool table tops. The power feeder mount can be placed anywhere on a cast iron drill press table, and finely positioned until it is in place. Once in position, each of the 2 powerful switchable magnets lock the vise in place for the power feeding.

- 2 ½" (5,08 cm) hole mounting pattern for medium to small power feeders
- Optional 4 magnet mounting plate with a 3 ½" (7,62 cm) by 4 ¼" (10,16cm) for large power feeders
- Powerful magnets provide a solid grip for high torque power feeding operations
- Switchable magnets allow for rapid positioning and clamping for a more efficient power feeding
- Low profile design maximizes vertical drilling capacity
- Eliminates need to drill and tap into table tops to mount power feeders



81001386



81001386



Power Feeder Mount

Part No.	81001386
Max. Breakaway	787 kg
Height	72,1 mm
Width	216,4 mm
Length	224,2 mm
Weight	4,5 kg



MagJigs

Applications: Woodworking, Fixturing, Clamping, Welding

It's a kind of MagJig! Secures your fixture easily into place. Simply turn the knob and feel the magic. Drill a hole in a fixture and place the MagJig in to use for downward pressure clamping.

- Secure your custom fixtures with the turn of a knob
- 3/4" (1,9 cm) standoff for standard material compatibility
- Screw holes for mounting to custom jigs and fixtures

Bulk quantities available for your custom applications, please contact cs@magswitch.com

-  High Heat Variants Available
-  Accessories Available



8100818



8100514



8110005



8110004



8100377



						
	MagJig 60 Keychain	MagJig 60	MagJig 95	MagJig 150	MagJig 235	Forstner Bit 30 mm & 40 mm
Part No.	8100514	8100818	8110004	8110005	8100377	180098 & 180099
Max. Breakaway	27 kg	27 kg	31 kg	60,5 kg	106 kg	30mm and 40mm Forstner Bits allow a hole to be drilled that will have the ideal fit to accommodate a MagJig 95 or 150
Height	43 mm	48 mm	46,6 mm	52,1 mm	82 mm	
Width	26,8 mm	26,8 mm	34 mm	44 mm	60 mm	
Length	39,5 mm	39,5 mm	57 mm	67 mm	88 mm	Allowing precision MagJig custom fixtures and tools to be constructed
Weight	0,1 kg	0,1 kg	0,2 kg	0,3 kg	0,6 kg	

Featherboards & Base Tools

Starter Kit

- Reversible Featherboard allows secure cutting on the left or right side of the fence
- Entry point for all Magswitch Universal Mounting Base Accessories

Universal Mounting Base

- Centerpiece of the Magswitch Workholding System
- Allows accessories to mount to cast-iron table top

Universal Featherboard and Universal Featherboard Pro

- Featherboard quickly locks in place for use on either side of the fence
- Pro only: Enhanced hold if placed on miter slots and micro-adjustable cross-cut stops

Vertical Featherboard with Risers*

- Adds a second stacked featherboard to a Starter Kit
- Keeps vertical workpieces pressed safely against the tool fence

Vertical Featherboard Pro

- Mounts to the table saw fence for downward pressure close to the blade
- Prevents ride-up and kickback



Website



						
	Starter Kit	Universal Mounting Base	Universal Featherboard	Universal Featherboard Pro	Vertical Featherboard with Risers	Vertical Featherboard Pro
Part No.	8110134	8110112	8110015	81101303	8110178	81101302

* Requires a Woodworking Starter Kit

Featherboards & Accessories

Pro Table Featherboard

- Powerful featherboard for extra workpiece stability
- Vertical Featherboard can be added for stacked horizontal or vertical featherboard

Riser Kit for Multi Level Workholding

- Designed for use with Pro Table Featherboard & Vertical Featherboard**
- Features 4 stackable risers to achieve multi level workholding and support. Allows for an adjustable, stackable featherboard
- Helps protect against kickbacks in the vertical and horizontal plane, allowing greater safety and quality of cut

Ultimate Thin Stock Jig*

- Holds down thin sheets on the table saw
- Makes repetitive table saw thin strip ripping safe and easy

Reversible Featherboard

- Sturdy yet lightweight woodworking featherboard is reversible for left and right hand feeds
- Perfect for infeed and outfeed applications
- Accommodates the Vertical Featherboard attachment and the Woodworking Starter Kit**

Universal Saw Indicator

- Works with stock miter gauges to measure blade and miter slot relative alignment
- Mounts to the table top for fence micro adjustments



8110328



8110328



81101326



8110134 & 8110155



8110112 & 8110362



8110112 & 8110362



8110328

					
	Pro Table Featherboard	Reversible Featherboard	Riser Kit for Multi Level Workholding	Universal Saw Indicator Metric	Ultimate Thin Stock Jig
Part No.	8110328	8110131	8110155	81101326	8110362

* Requires a Woodworking Starter Kit

** Each sold separately

Featherboards & Accessories

SavR Featherboard

- Provides strong featherboard force against the tablesaw fence in either left handed or right handed positions
- Compressible gaskets provide excellent gri when cam is engaged
- Quick locking

Stacked SavR Featherboard

- Dual-Pressure Design: The Stacked SavR Featherboard Kit adds a second level of feather boards, applying additional hold-down pressure for enhanced workpiece stability
- Simple Installation: Easily attachable without extra tools; the kit integrates with the original SavR Featherboard for a quick upgrade

SavR Push Block

- A docking station that can mount to any surface, we recommend the center of the table saw fence
- The base is replaceable, so when it inevitably gets chewed up by the saw blade it can be replaced

Replacement Kit For SavR Push Block Base

- Quick to replace in under a minute
- Restores a SavR Push Block to new condition
- Strong MDF hlds workpiece steady but can safely contact the table saw blade



81101513 & 81101514



81101513



81101514



88001695 & 81101514



81101513 & 81101514



81101513



81101514



SavR Featherboard



Stacked SavR Featherboard



SavR Push Block



Replacement Kit For SavR Push Block Base

Part No.	81101513	88001695	81101514	88001540
----------	----------	----------	----------	----------

Tracks & Guides

Drill Press Fence and Drill Press Fence Pro

- Quick to reposition and remove
- Compatible with large and small drill presses
- Magnetic stop block works with any thickness backer board
- Pro Only: Doubles as a tall bandsaw fence

Dual Roller Guide* and Resaw Guide*

- Low friction, vertical support for the workpiece
- Adjustable to a precise 90 degree angle

18" Universal Track* & 36" Universal Track*

- Solid, customizable aluminum fence
- Compatible with many tools including the drill press and band saw

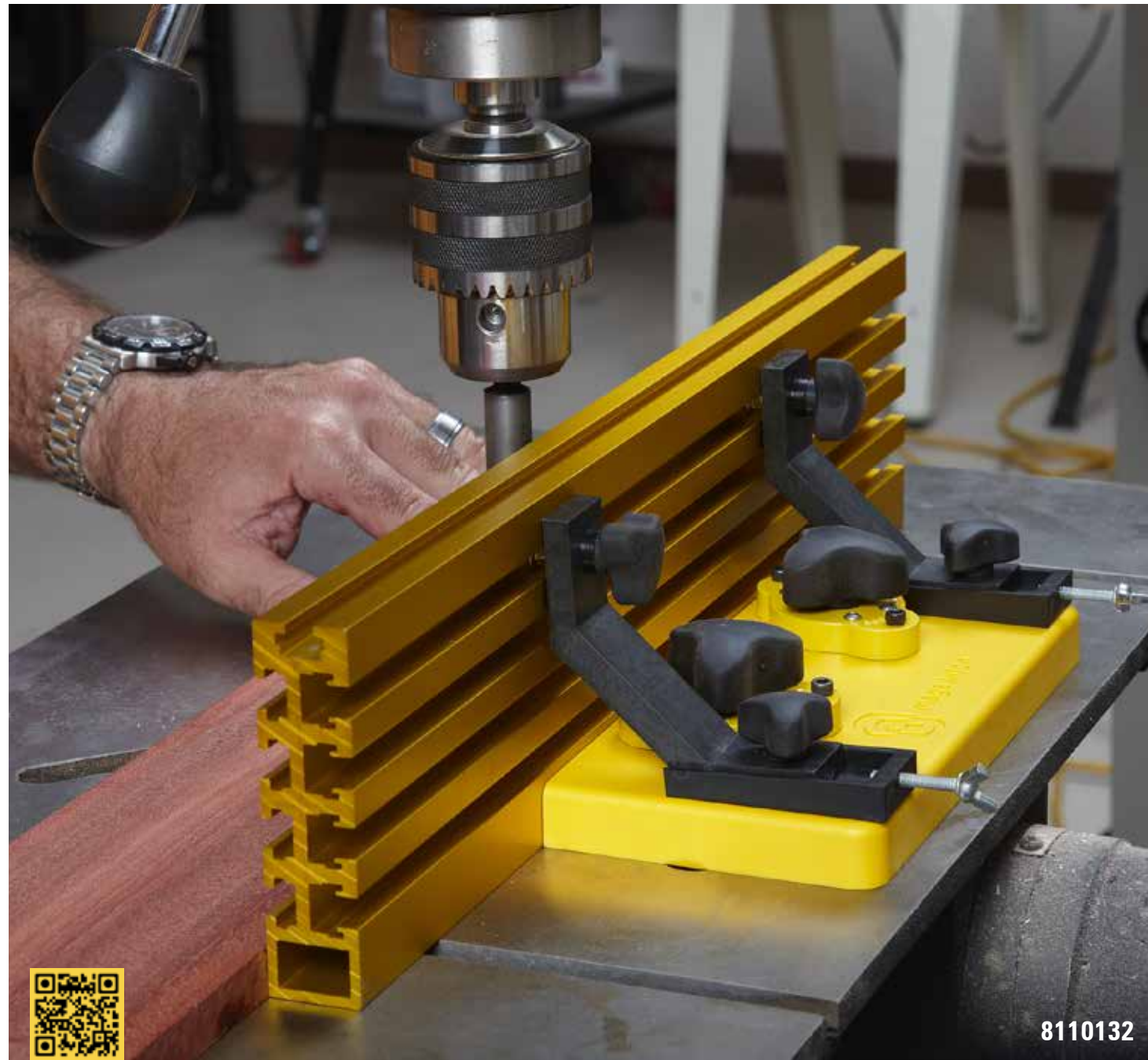

						
	Drill Press Fence	Drill Press Fence Pro	18" Universal Track	36" Universal Track	Dual Roller Guide	Resaw Guide
Part No.	81101375	81101371	8110132	8110370	8110130	8110125

* Requires a Woodworking Starter Kit

Magswitch Solutions - At Every Step Of The Way

- Shipbuilding/Ship Fitting
- Welding & Fabrication
- Material Handling
- Material Alignment

- Lifting Tools
- Heavy Lifting Solutions
- Automation



Heavy Lifting Solutions



Material Handling



Welding & Fabrication



Material Alignment



Lifting Tools



Automation

Magswitch Integration Into Your Products

Put Magswitch to work for you, use Magswitch in your products. We provide a whole range of expertise from design engineering and manufacturing to marketing. Combining our technology with professional expertise, we can create specialized products that fit your needs and budget.

Join the list of companies who have integrated Magswitch into their products to gain advantages

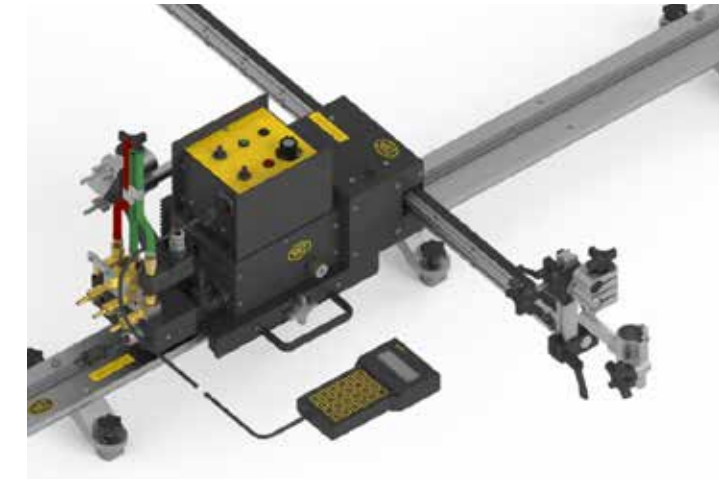

Partner with Magswitch - Private Branding, Co-Branding



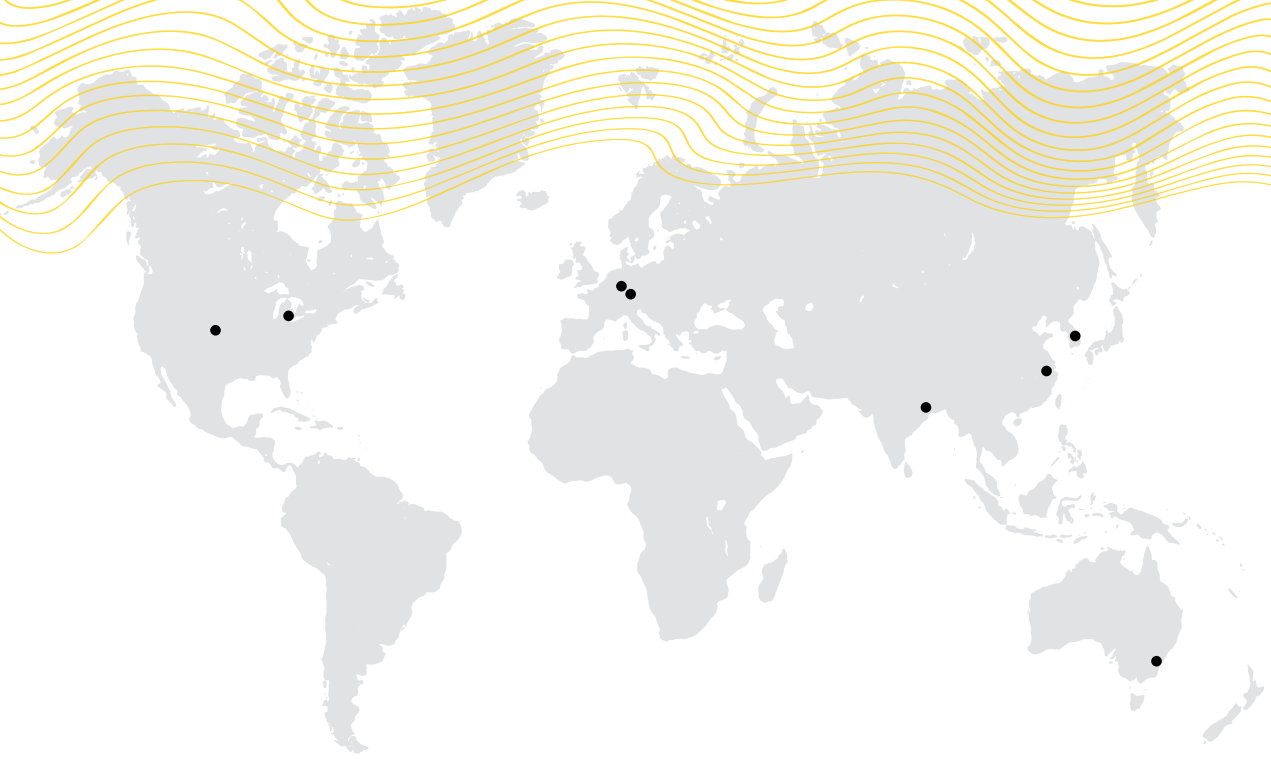

Magswitch Technology Europe GmbH

Marie-Curie-Str. 12
85055 Ingolstadt, Germany
+49 (841) 883544-0
cs@magswitch.com

Magswitch Technology Europe GmbH

Eisenstraße 51
65428 Rüsselsheim, Germany
+49 (0) 6142 60358-00
cs@magswitch.com

Magswitch Technologies

1000 S. McCaslin Blvd., Suite 301,
Superior, Colorado 80027, United States
+1 (303) 468.0662
sales@magswitch.com

Magswitch Technology China Co. Ltd.

4th Floor, No. 1711, Xingqiao North Road
Yuhang District, Hangzhou 311100, China
+86 (571) 86260710 8014
cs@magswitch.com

Visit our website!

www.magswitch.com



2024 V1 EU

Subject to technical and color changes. No liability for errors and misprints assumed.
© Magswitch Technology Europe GmbH 2024